



Colt-Lamellenprofile

Profilübersicht Solar C

Brandschutz	Colt International GmbH
	Region West
Gebäudedesign	Briener Straße 186
	D-47533 Kleve
Klimatechnik	Tel.: +49(0)2821-990-403
	Fax: +49(0)2821-990-310
	colt-west@de.coltgroup.com
Service & Wartung	www.coltgroup.com

Profilübersicht Solar C

ALLGEMEINE TECHNISCHE DATEN:

Die hier aufgeführten Profile geben lediglich den aktuellen Bestand an. Selbstverständlich besteht die Möglichkeit, projektspezifische Individualanforderungen zu berücksichtigen. Sprechen Sie einfach mit einem unserer Kundenberater. Alle Maße verstehen sich als Breiten-, Höhen- oder Breite x Höhe Angaben.

Toleranzen: EN 120 20
 Oberflächenbehandlung: Eloxierung gemäß EURAS, Pulverbeschichtung gemäß GSB, Nasslackbeschichtung
 Werkstoff: Al Mg Si O,5
 Güte: F22

SOLAR C-PROFILE

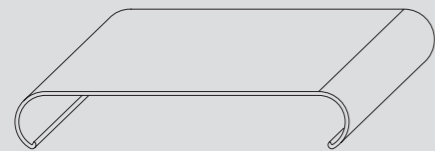

C 100 – 100 mm

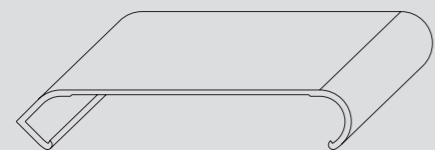

C 106 – 106 mm

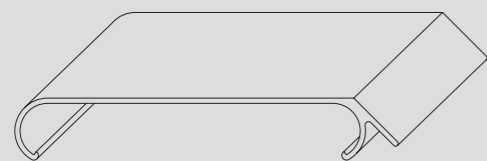

C 110 – 110 mm

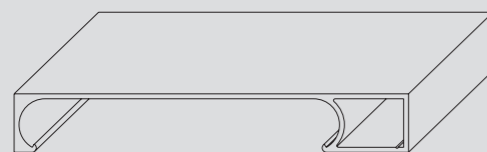

C 120 R – 120 mm

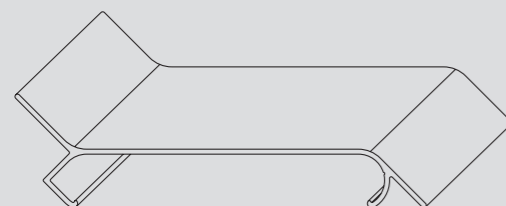

C 124 Z – 124 mm



C 140 – 140 mm *

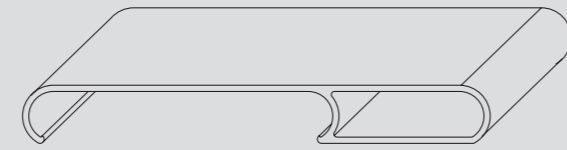

C 150 G – 150 mm *

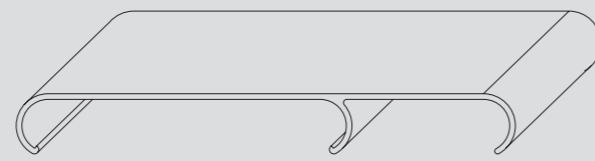

C 150 – 150 mm *

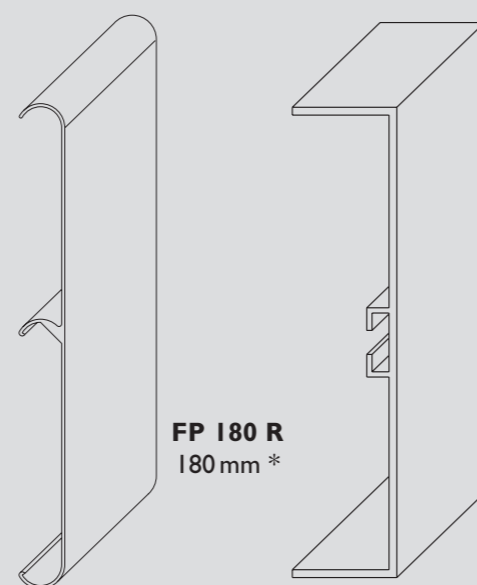

FP 180 R
180 mm *

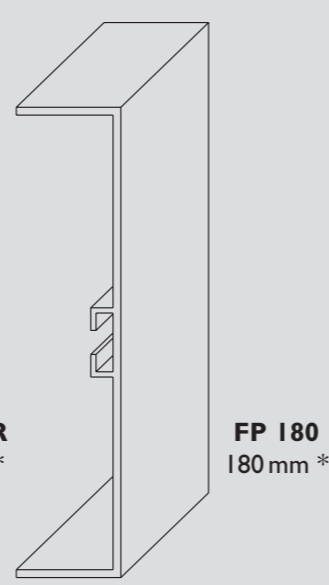

FP 180
180 mm *

SOLAR C-TRÄGERPROFILE

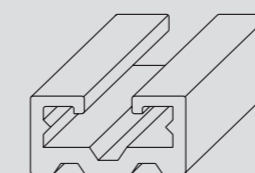

TP 15 30 – 30x15 mm *

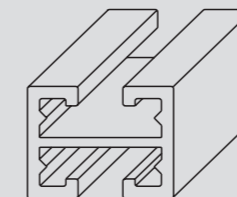

TP 23 30 – 30x23 mm *

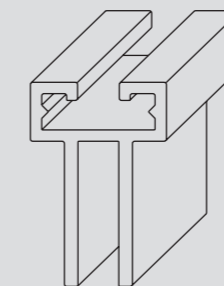

TP 45 30 – 30x45 mm

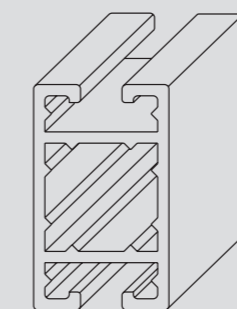

TP 50 30 – 30x50 mm *

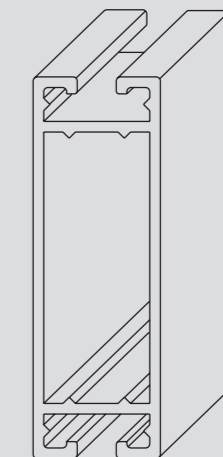

TP 90 30 – 30x90 mm *

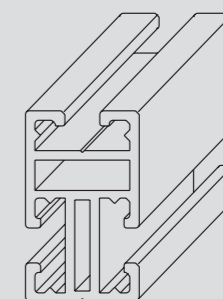

TP 50 30 3 – 30x50 mm

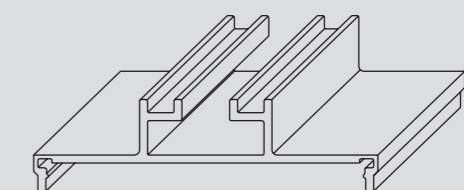

TP Azur – 65x17,5 mm

* Colt-Standardprofile

